

Varenummer: 20956604
 Beskrivelse: E+G Justerfod
 GN 342.2-40-M12-63-SV

Mål

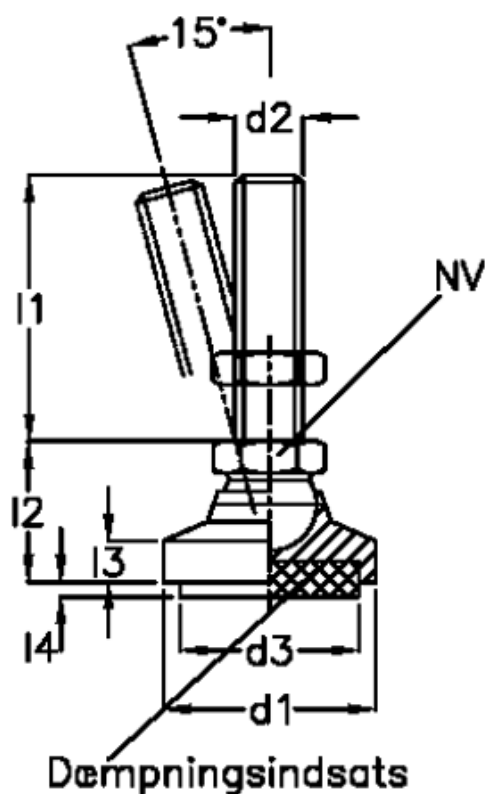

Area(m ²) damping insert = 1134	l4 compression 0,4 N/mm ²	= 4.8
d1 = 40	l4 compression 0,6 N/mm ²	= 3.9
d2 = M12	Load (N) by compression 0,4 N/mm ²	= 450
d3 = 38	NV	= 18
l1 = 63	t	= 11.5
l2 = 30.0		
l3 = 9.5		
l4 compression 0 N/mm ² = 6.0		